



十速

T-Link-EV5284/5288

User Manual

Rev 0.93

tenx reserves the right to change or discontinue the manual and online documentation to this product herein to improve reliability, function or design without further notice. **tenx** does not assume any liability arising out of the application or use of any product or circuit described herein; neither does it convey any license under its patent rights nor the rights of others. **tenx** products are not designed, intended, or authorized for use in life support appliances, devices, or systems. If Buyer purchases or uses **tenx** products for any such unintended or unauthorized application, Buyer shall indemnify and hold **tenx** and its officers, employees, subsidiaries, affiliates and distributors harmless against all claims, cost, damages, and expenses, and reasonable attorney fees arising out of, directly or indirectly, any claim of personal injury or death associated with such unintended or unauthorized use even if such claim alleges that **tenx** was negligent regarding the design or manufacture of the part.

AMENDMENT HISTORY

Version	Date	Description
V0.90	Feb, 2014	New release
V0.91	Oct, 2014	1.全部圖檔重新修改 Modify all of Drawing 2.新增 P4 : 圖檔 Added Drawing (P4) 3.新增 P11 : 圖檔及文字 Added Drawing & Writing (P11) 4.新增 P18 : 4.18 Added 4.18 (P18) 5.新增 P20 : 第 5 大項 Added The first five items (P20) 6.新增 P23 : Q1 Added : Q1 (P23)
V0.92	May, 2015	1.修改 P4 圖檔 2.修改 P7 文字及圖檔 3.新增 P20 文字及圖檔 4.新增 P21 文字及圖檔 5.新增 P22 文字及圖檔 6.新增 P27 文字 7.修改 P29 圖檔 8.修改 P30 圖檔
V0.93	Sep, 2015	1.新增 P26~27 文字及圖檔

CONTENTS

AMENDMENT HISTORY	2
1. Outline.....	4
2. Introduction.....	4
3. T-Link-EV5284/5288 Hardware Description	5
4. How to start using T-Link-EV5284/5288 simulation.....	7
5. How to use four wires to program or simulate by T-Link Board.....	19
6. How to update tenx IDE & T-Link F/W	20
7. How to use Touch Key Application	22
8. How to use LCD Application	26
9. LVR Setting Notes.....	28
10. Q & A	29

1. Outline

Tenx (tenx technology) F51 & L51 Series single-chip is compatible with 8051, the user can use Keil uVision series of software as a development environment, this article will introduce the software and hardware configuration in Keil C.

2. Introduction

Figure 2-1 is T-Link-EV5284/5288 development board, the left portion is called EV5284/5288 Board and the right portion is called T-Link ICE Board to connect PC to use, the user can simulate TM52F5284/5288 through this development board, please refer to TM52F5284/5288 datasheet in detail.

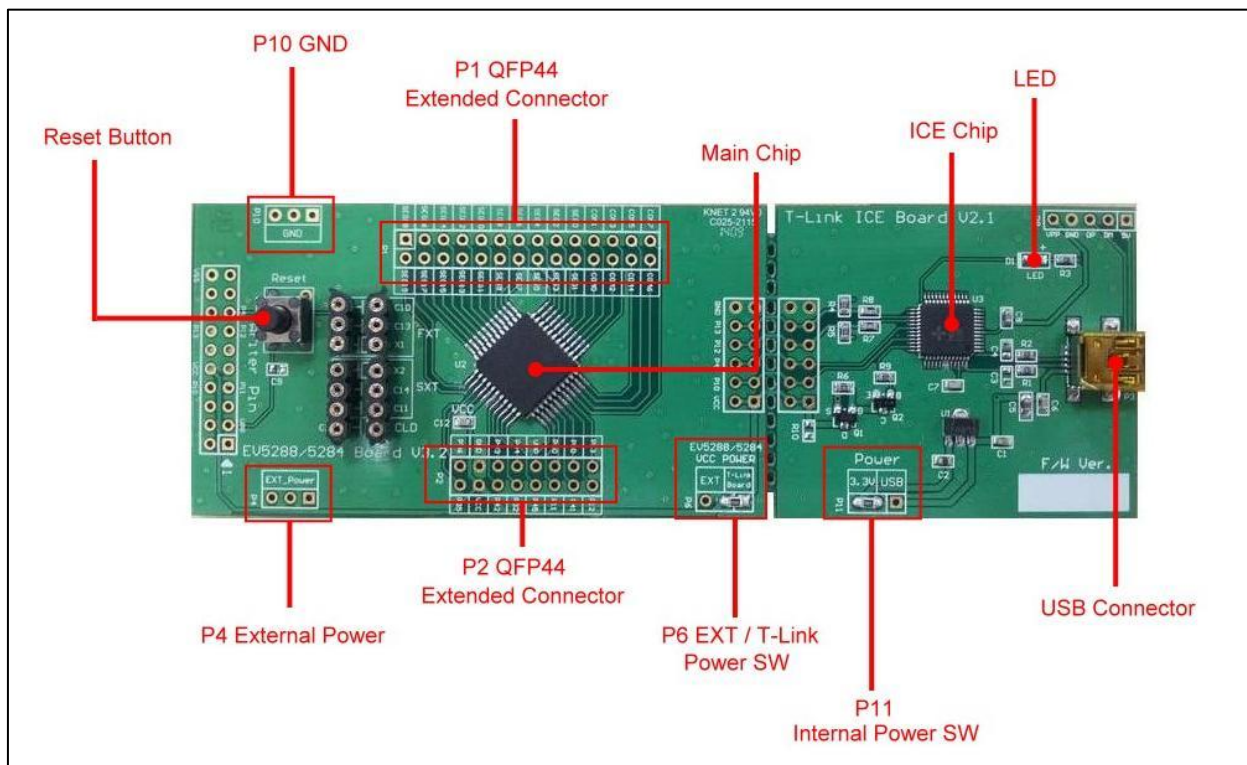
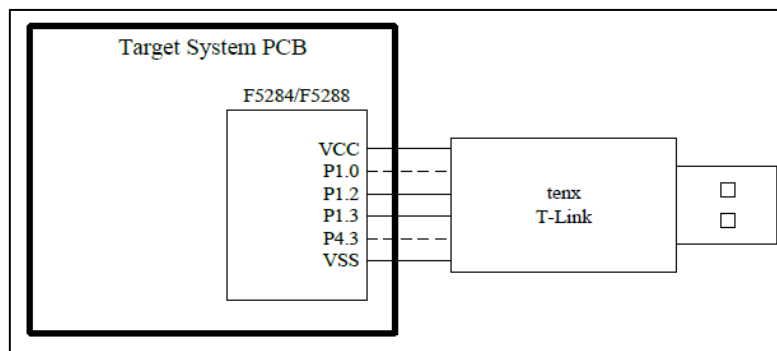

Figure 2-1. T-Link-EV5284/5288 Board



3. T-Link-EV5284/5288 Hardware Description

3.1 Power Setting

- P4: Connect to external power (EV5284/5288 Board)
- P6: Internal or external power source selection (EV5284/5288 Board)
- P11: Internal power selection (T-Link Board)

MCU Power	P11	P4	P6
External Power	USB or 3.3V	EXT_Power	EXT
Internal Power	USB or 3.3V	X	T-Link Board

3.2 USB Connector

- P3: Mini USB connector to PC (T-Link Board)

3.3 Reset Button

- Reset: Reset Button (EV5284/5288 Board)

3.4 External Power Connector

- P4: External VCC connector (EV5284/5288 Board)
- P10: External GND connector (EV5284/5288 Board)

3.5 MCU External Frequency-FXT

- X1: FXT (1~6M) (EV5284/5288 Board)
- C10: matching capacitor (EV5284/5288 Board)
- C13: matching capacitor (EV5284/5288 Board)

3.6 MCU External Frequency-SXT

- X2: SXT (32.768K) (EV5284/5288 Board)
- C11: matching capacitor (EV5284/5288 Board)
- C14: matching capacitor (EV5284/5288 Board)

3.7 PIN Assignment & Description

EV5284/5288 Board contains TM52F5284/5288 main chip, packaged is QFP 44-pin as shown below table for the pin assignment instructions.

Pin Number	Pin Name	Pin Number	Pin Name
1	MISO/INT1/SEG18/P3.3	23	COM3/P2.0
2	SS/T0/SEG19/P3.4	24	COM2/P2.1
3	TK11/MOSI/T1/P3.5	25	COM1/P2.2
4	TK10/SCK/P3.6	26	COM0/P2.3
5	VCC	27	SEG0/P2.4
6	VSS	28	SEG1/P2.5
7	FXO/P4.2	29	SEG2/P2.6
8	FXI/P4.3	30	SEG3/P2.7
9	CLD/INT0/P3.2	31	SEG4/P0.0
10	SXI/P4.4	32	SEG5/P0.1
11	SXO/P4.5	33	SEG6/P0.2
12	VPP/RSTn/INT2/P4.7	34	SEG7/P0.3
13	TK9/T2EX/AD9/P1.1	35	SEG8/P0.4
14	TK8/AD8/P4.0	36	SEG9/P0.5
15	TK7/PWM0B/AD7/P4.1	37	SEG10/P0.6
16	TK6/T2/AD6/P1.0	38	SEG11/P0.7
17	TK5/AD5/P1.2	39	SEG12/P5.0
18	TK4/AD4/P1.3	40	SEG13/P5.1
19	TK3/PWM0A/AD3/COM7/P1.4	41	SEG14/P5.2
20	TK2/PWM1/AD2/COM6/P1.5	42	SEG15/P3.7
21	TK1/AD1/COM5/P1.6	43	RXD/SEG16/P3.0
22	TK0/AD0/COM4/P1.7	44	TXD/SEG17/P3.1

4. How to start using T-Link-EV5284/5288 simulation

First, Install the tenx TM52DII IDE file to follow steps to complete the installation, the IDE & Keil C version must be installed in the same path, the default path is C:\ Keil:

4.1 Select Keil C version, click “Next>”

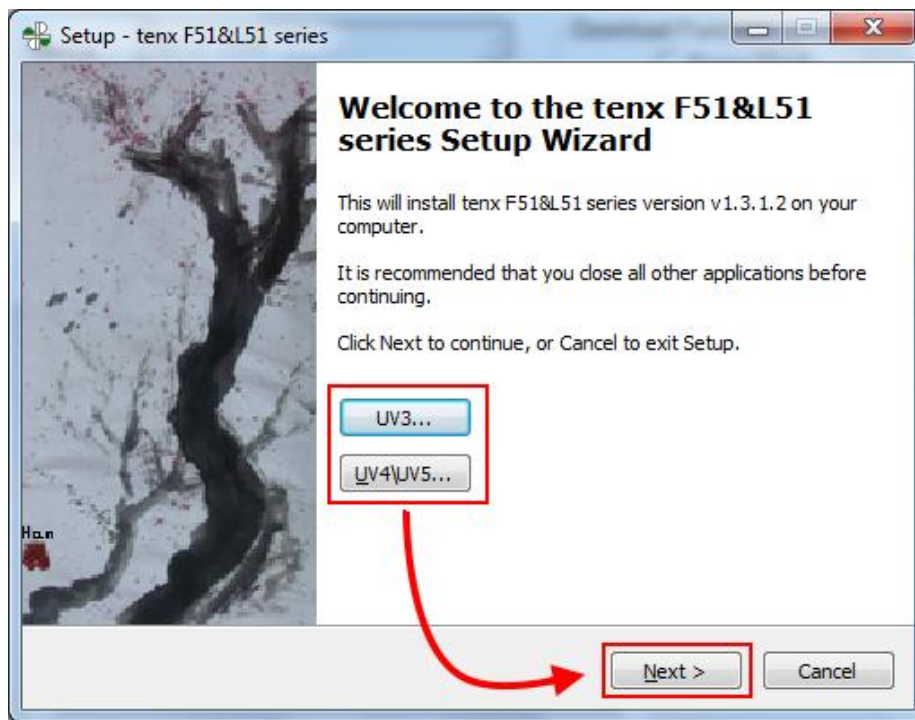

4.2 And then click “Next>”

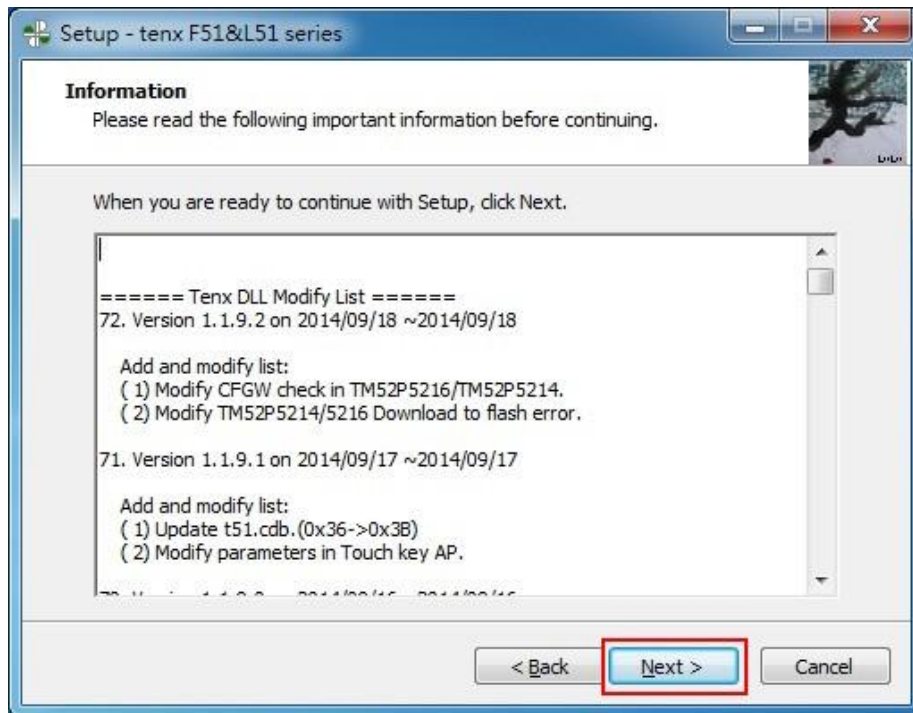

4.3 The default path is C:\ Keil, click “Next>”

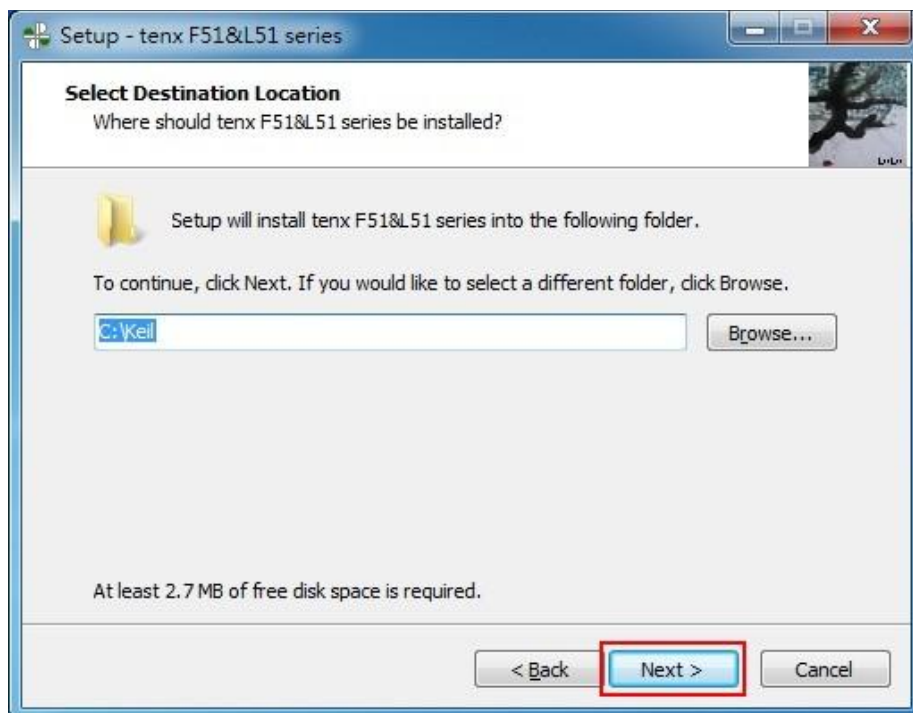

4.4 Click “Install”

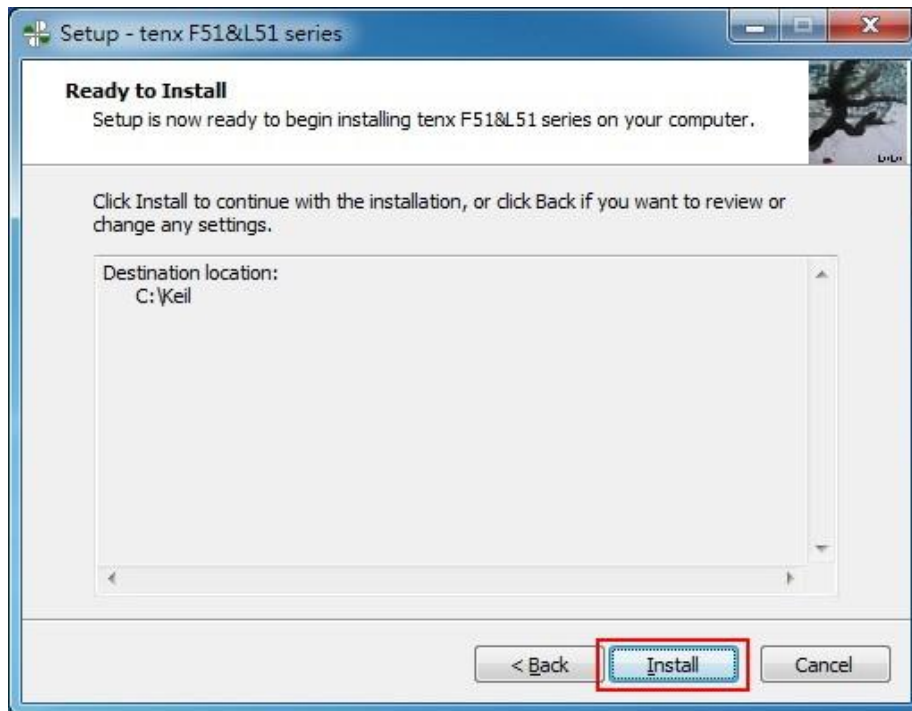

4.5 Click “Finish” to complete the installation



4.6 Connect T-Link-EV5284/5288 Board of USB (mini type) connector to PC

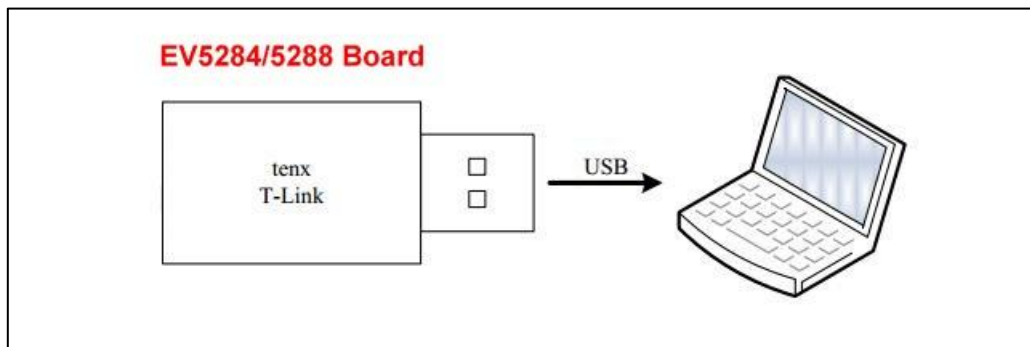

4.7 Confirm Device Manger

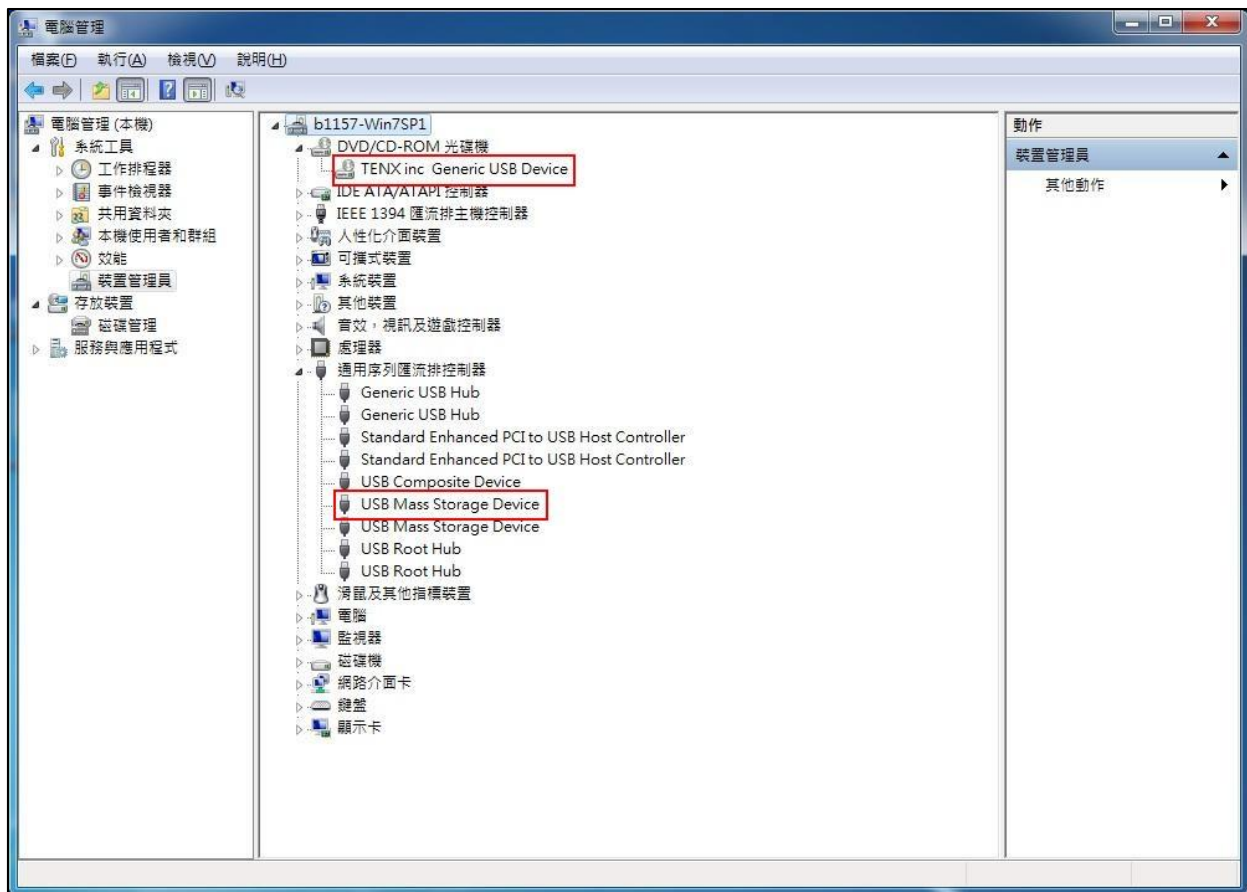

4.8 Open the KEIL C → Click the Project menu and select New Project window → Fill in the project name and click Save Project → Copy tenx 8051 Startup Code or not ?

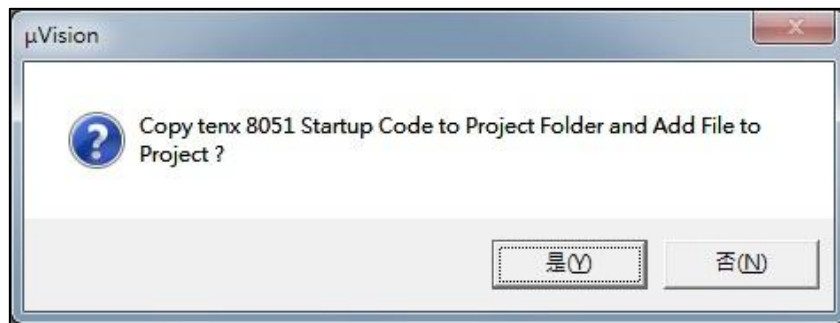
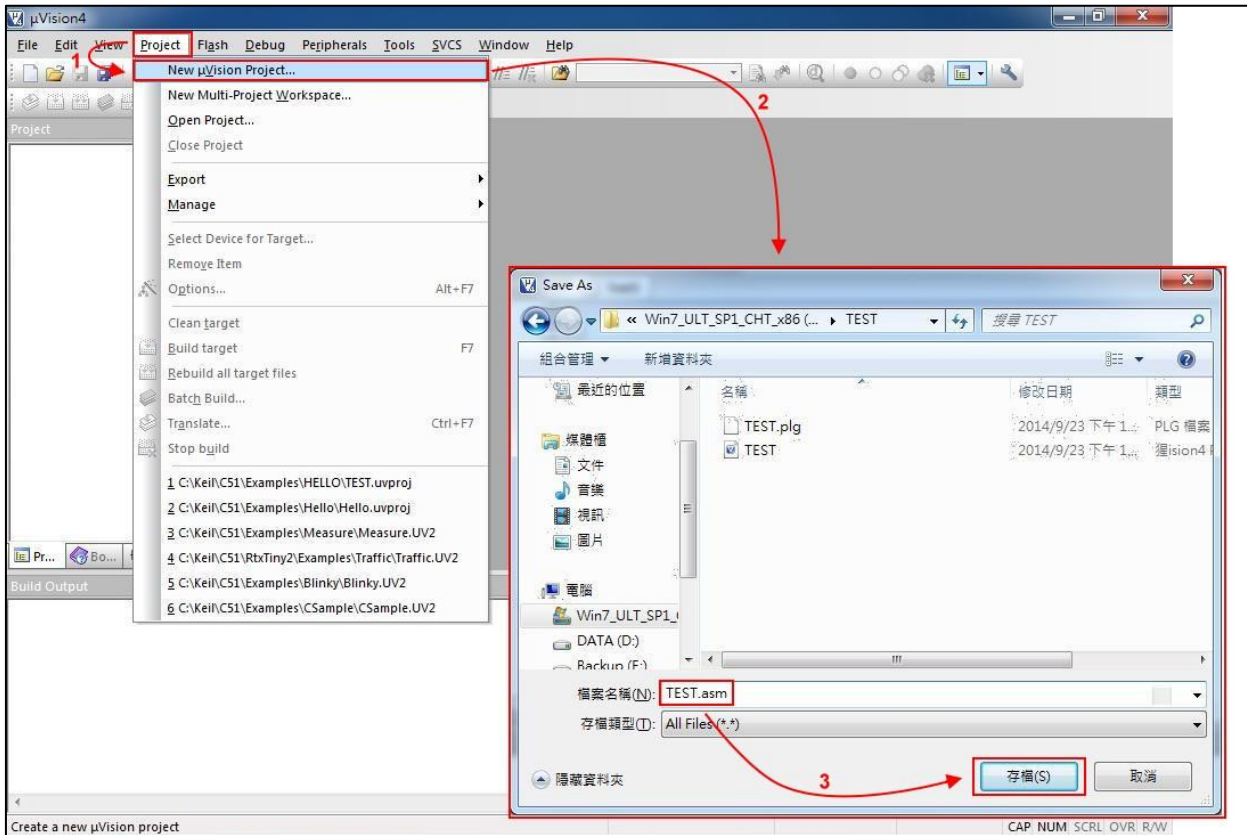

4.9 CPU Data Base selection dialog box will be show up → Select the tenx F8051 Devices and click on OK button → Select a CPU model (for EV Board model), refer to Note (1) and the right window shows some of the parameters of this single chip model.

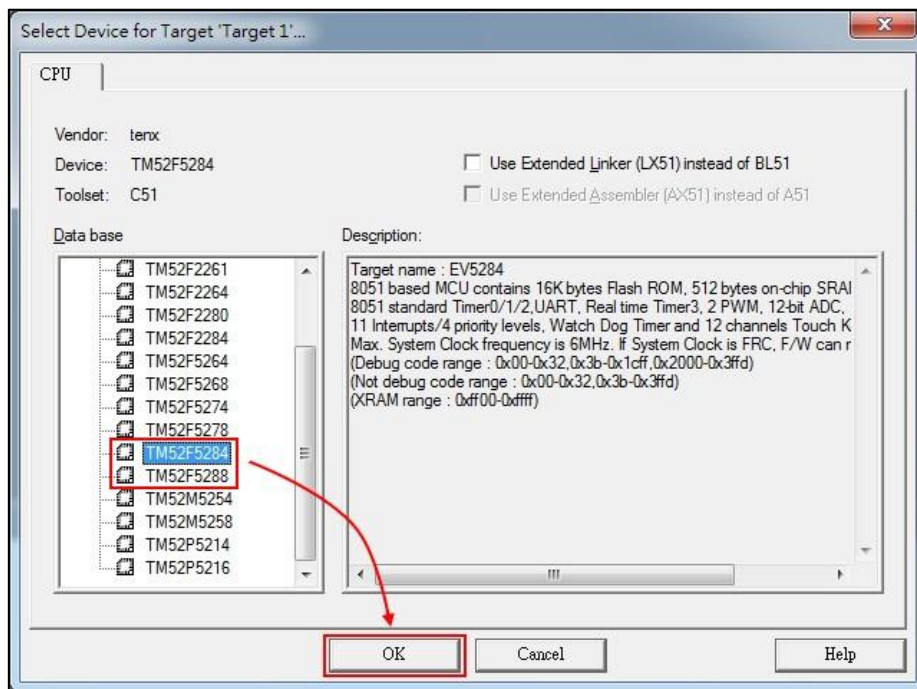
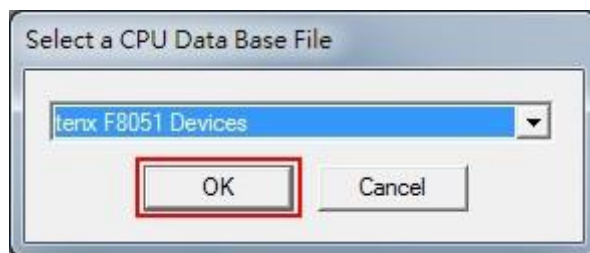
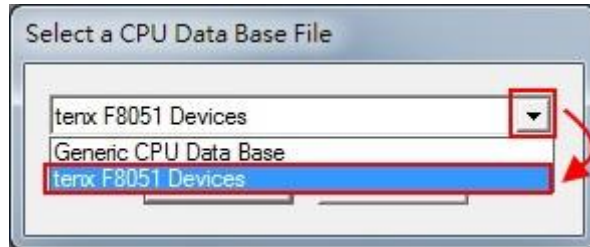

Note (1): TM52F5284/5288 (For EV Board model)

Chip Model	EV Board Model
TM52F5284	EV5284/5288
TM52F5288	

4.10 Option for Target dialog box settings: Click the “Option for Target” button in the main menu, the project file is created must also be relevant to the project file settings as shown below.

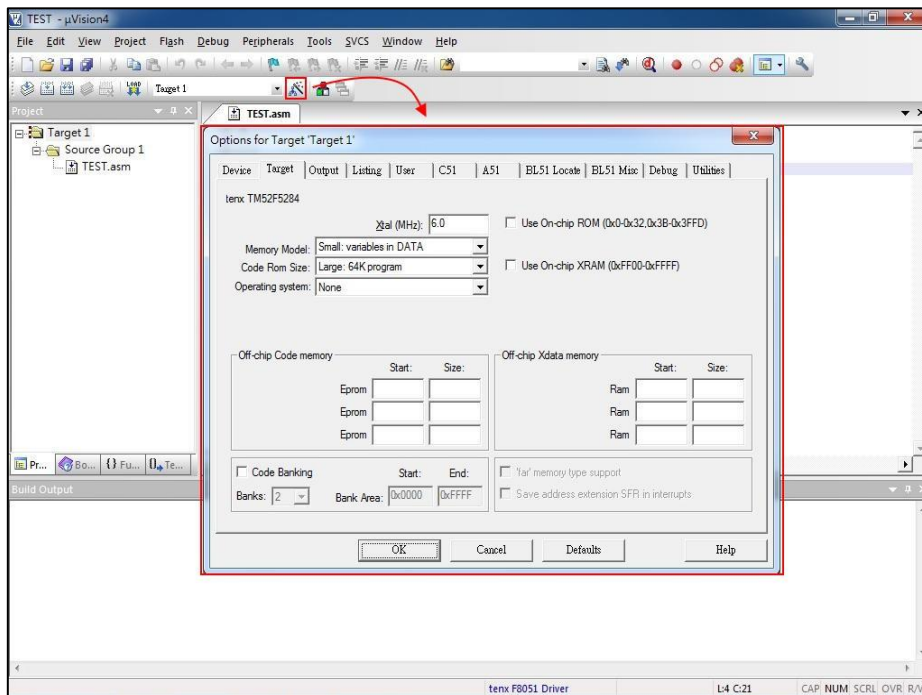

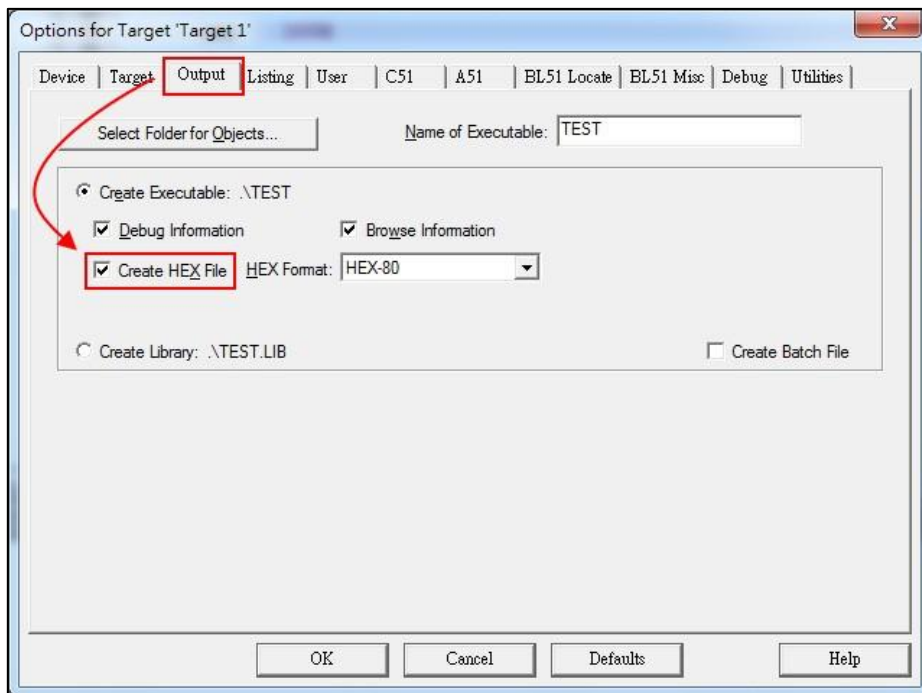

4.11 Output dialog box settings: To confirm “Create HEX File” option is checked, as shown below.

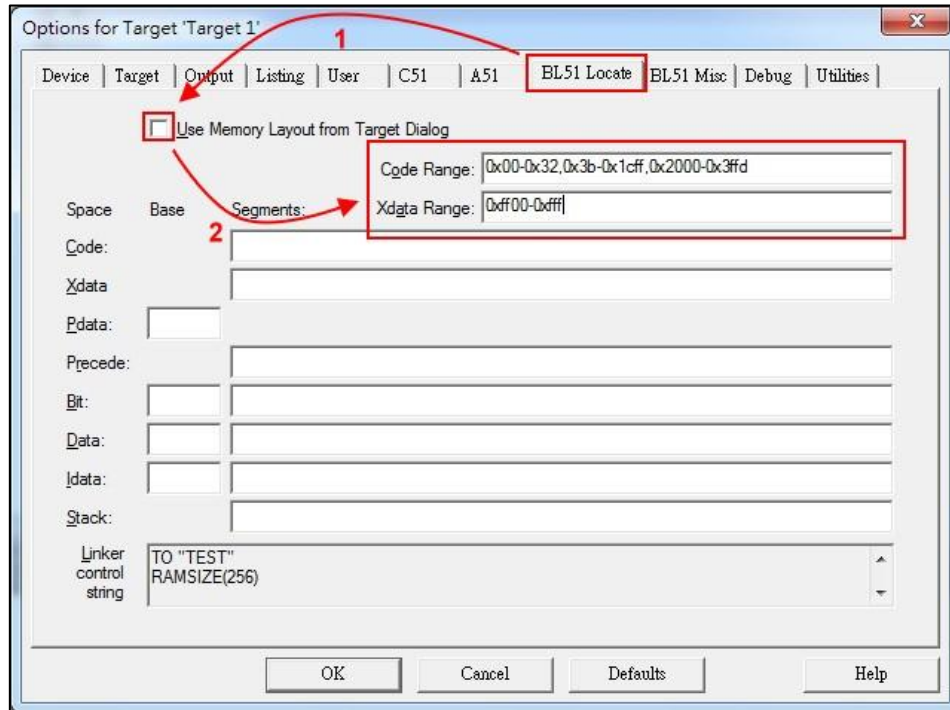

4.12 BL51 Locate dialog box settings: Unchecked “Use Memory Layout from Target Dialog” in BL51 Locate option and fill in Code & Xdata Range (Note: The chip code available range has divided into download mode and debug mode , please refer to Note (2))



Note (2): TM52F5284/5288 (EV5284/5288) Code Range area (Program ROM)

Chip Model	Code Range		XRAM Range
	Download Mode 	Debug Mode 	
TM52F5284/5288 (EV5284/5288)	0x00-0x32, 0x3b-0x3ffe	0x00-0x32, 0x3b-0x1cff, 0x2000-0x3ffd	0xff00-0xffff

4.13 Debug dialog box settings: Click on “Use:” option, and then select “tenx F8051 Driver” as shown below.

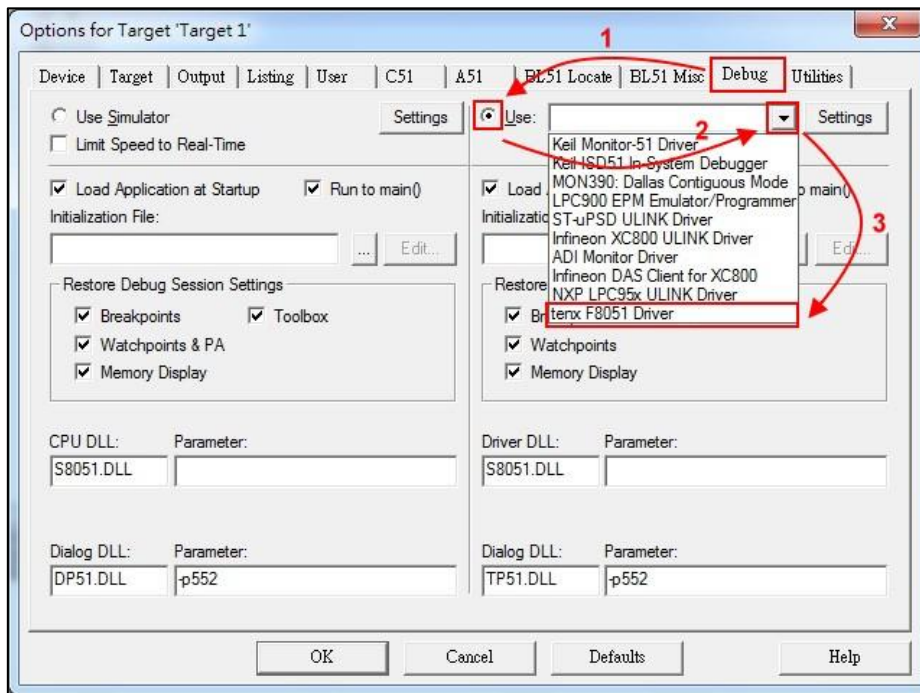

4.14 Utilities dialog box settings: Click on “Use Target Driver for Flash Programming” option and select “tenx F8051 Driver” as shown below.

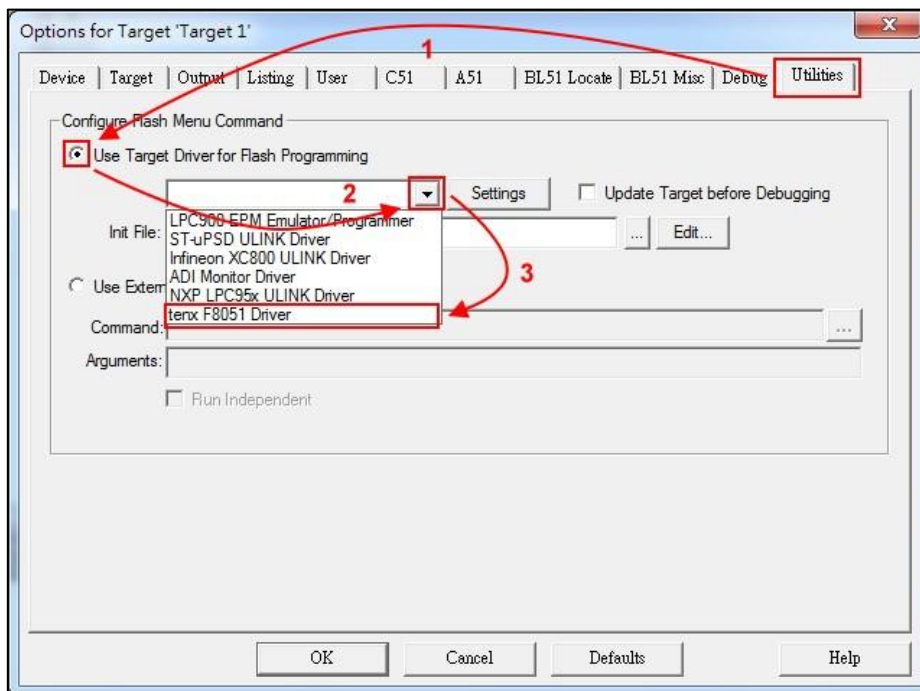

4.15 Click on “settings” button and the “Flash Download Setup” window will be show up, check the “Download Function” desired option as shown below.

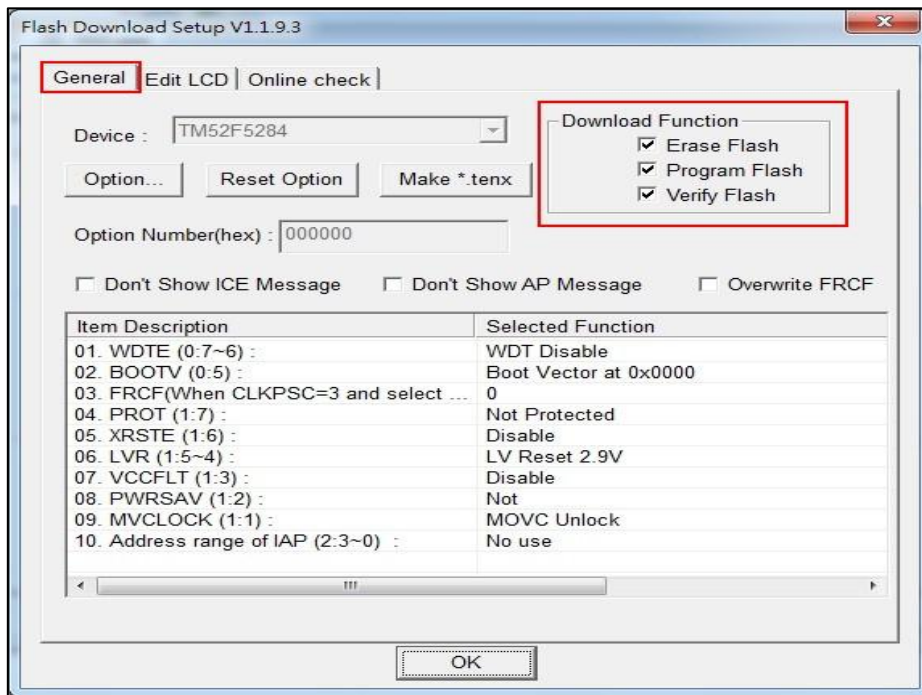

4.16 Click on “Option” button, and the “Smart Option” will be show up, about the option configuration, please refer to TM52F5284/5288 datasheet.

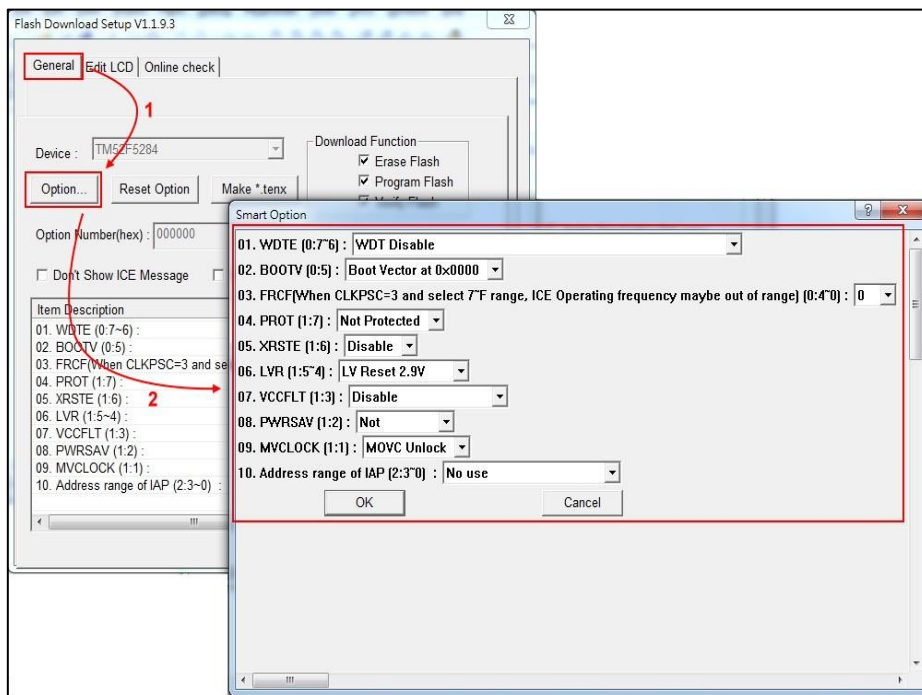

4.17 FRCF (Fast Internal RC) settings: Click on “Option” button after the “Overwrite FRCF” is checked, the user can adjustment 32 frequency levels (The default is 7.3 Mhz). (Note: When CLKPSC=11 and select 7~F range, ICE Operating frequency is out of range)

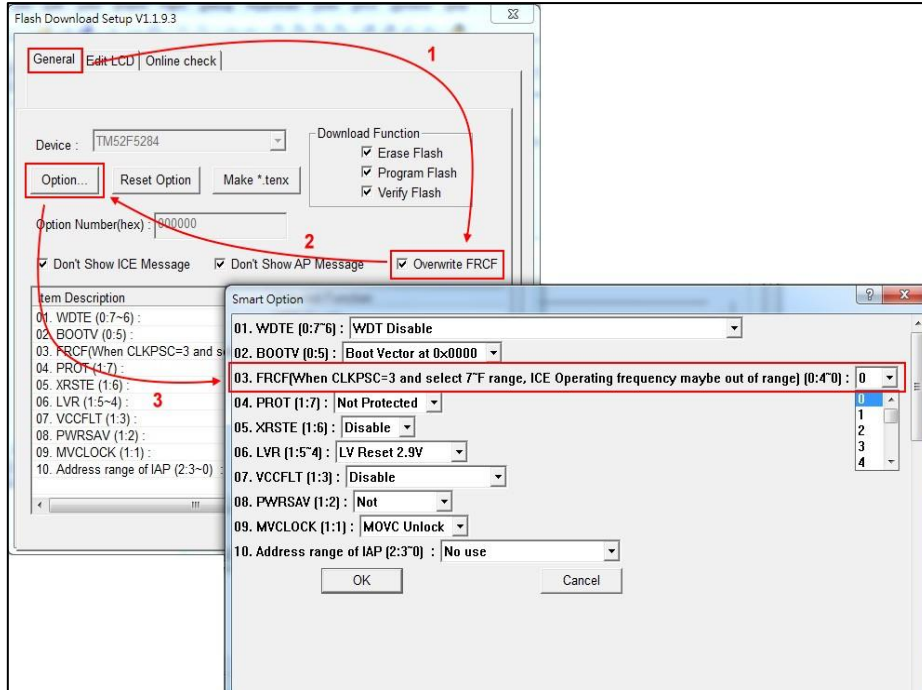

4.18 Click on “OK” to return to “Flash Download Setup” window, and then click on “OK” to return to “Utilities” window, this all new project configuration is complete and click on “OK” to exit the “Option for Target” window, the user can start programming now. (Note: To change chip model ,user needs to confirm “Code Range” and “Option” settings, the “Open Project” will save the settings and the “New Project” will be default settings in the “Option” dialog box)

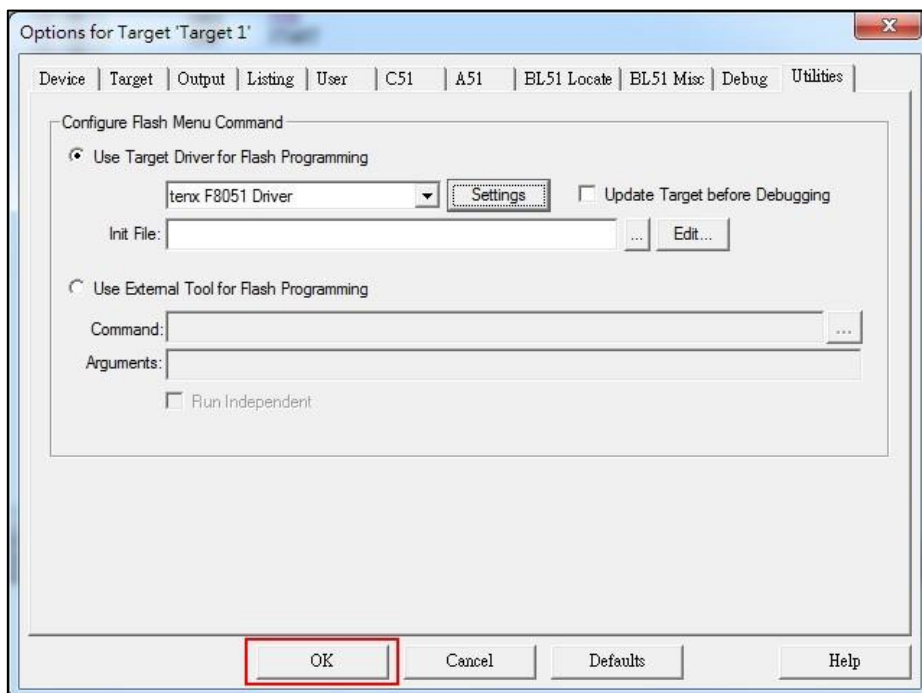
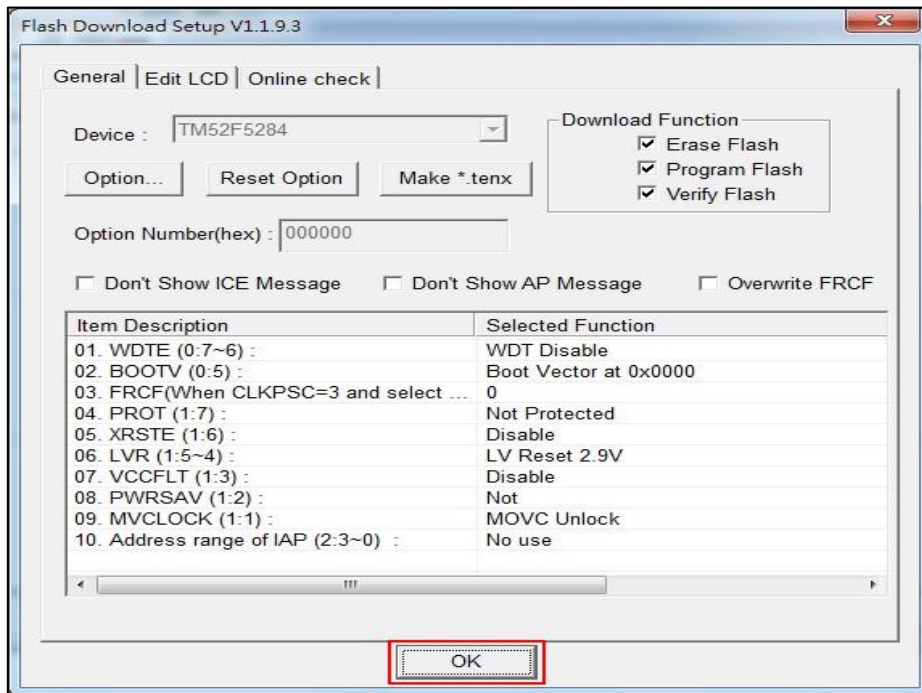

5. How to use four wires to program or simulate by T-Link Board

The T-Link ICE Board can use four wires (VCC, VSS, P1.2, P1.3) or six wires (VCC, VSS, P1.2, P1.3, P1.0, P4.3) to program, user must to select 4-wire in “Utilities dialog box settings”.

5.1 Utilities dialog box settings: Click on “Option” button, and select 4-Wire, as shown below.

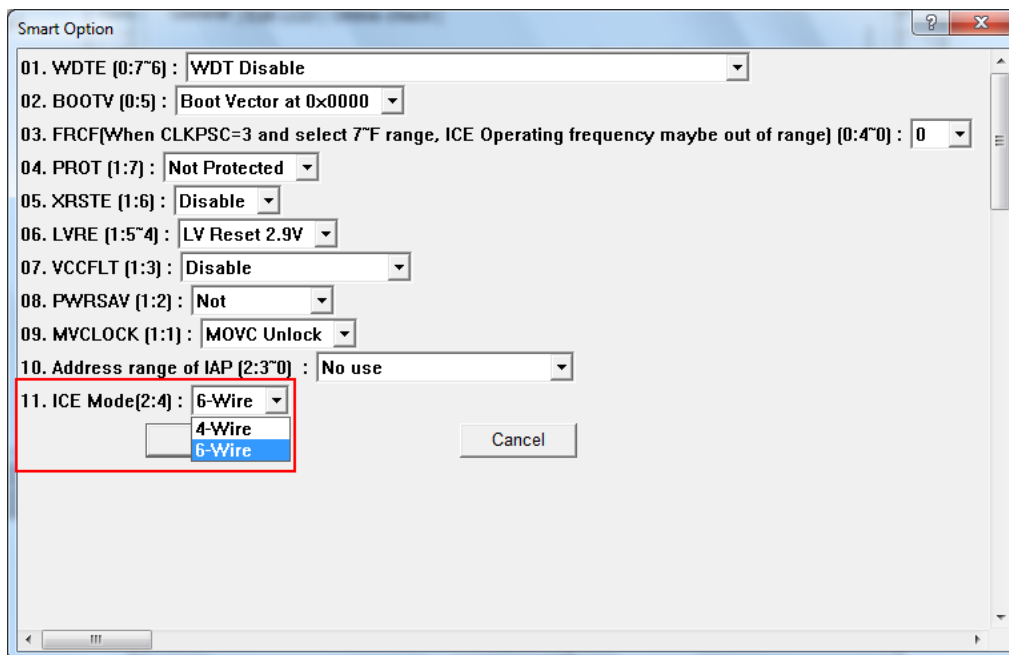

6. How to update tenx IDE & T-Link F/W

6.1 Update tenx IDE: Click on “Online check” button, and Update the TM52DI1 IDE in Utilities dialog box, as shown below.

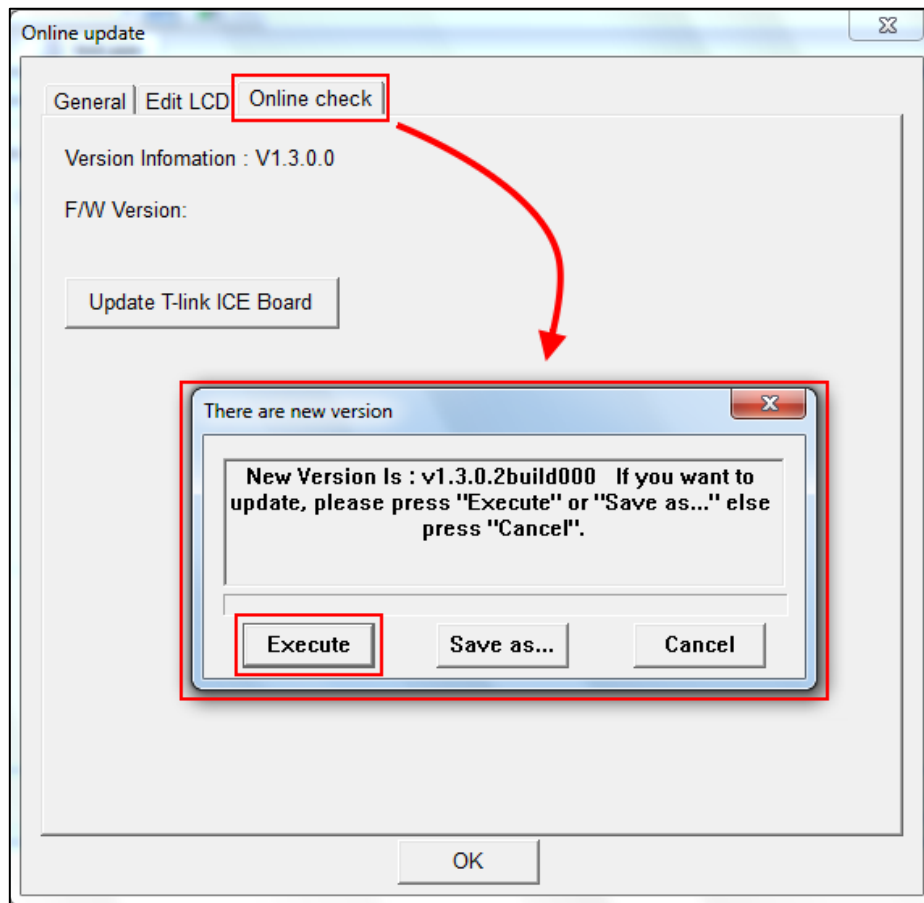

6.2 Update T-Link F/W: Connect TUT52 Writer to USB and T-Link Board, as shown below.

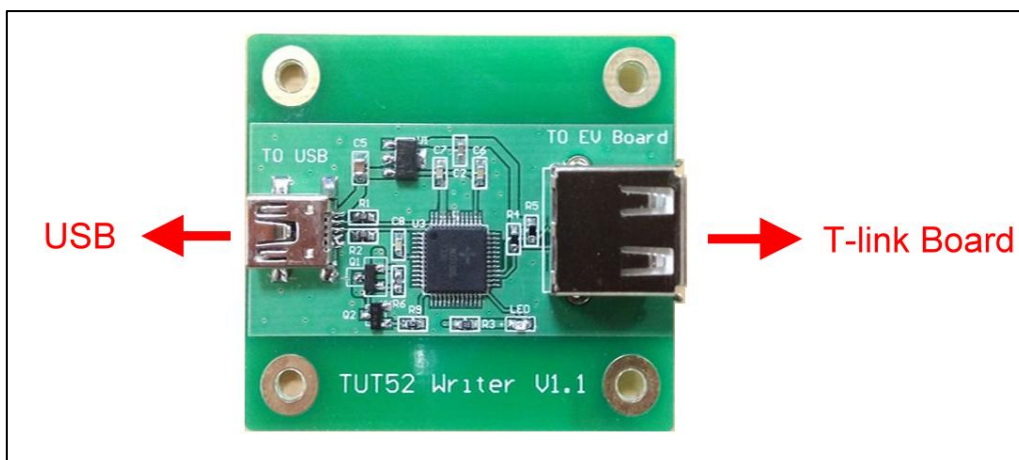

6.3 Click on “Update T-Link ICE Board” button to update T-Link Board F/W, as shown below.

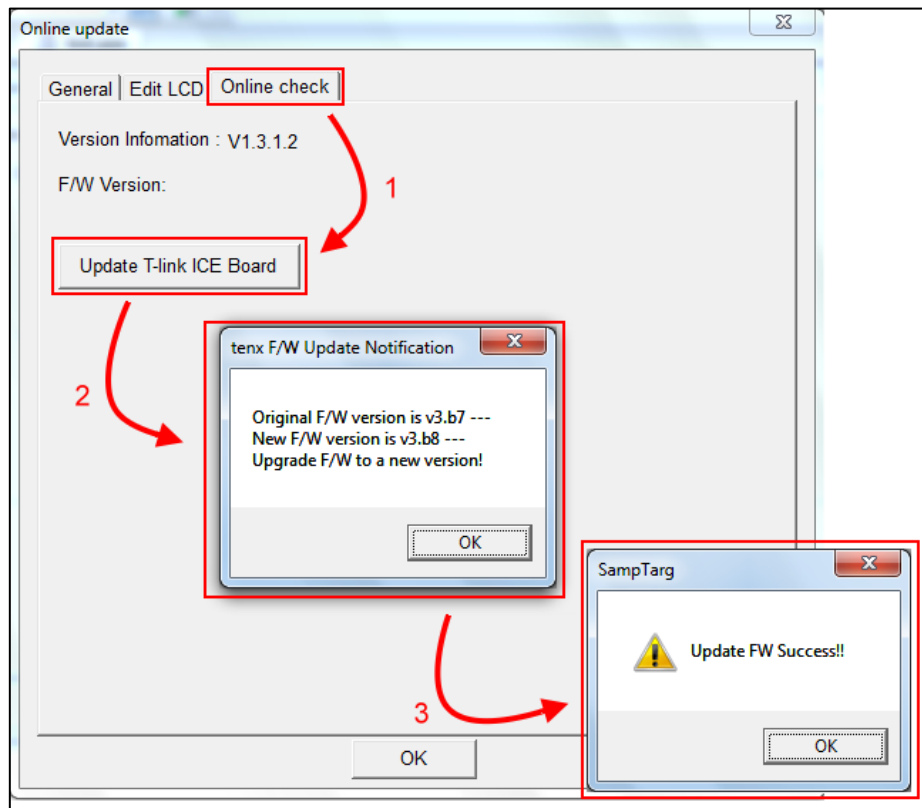

7. How to use Touch Key Application

The Touch Key Application work in Debug Mode, user can use application to view the results of TK Data. The TK Data must be stored in XRAM and IRAM range, as shown below.

7.1 Click on “Debug” into Debug mode.

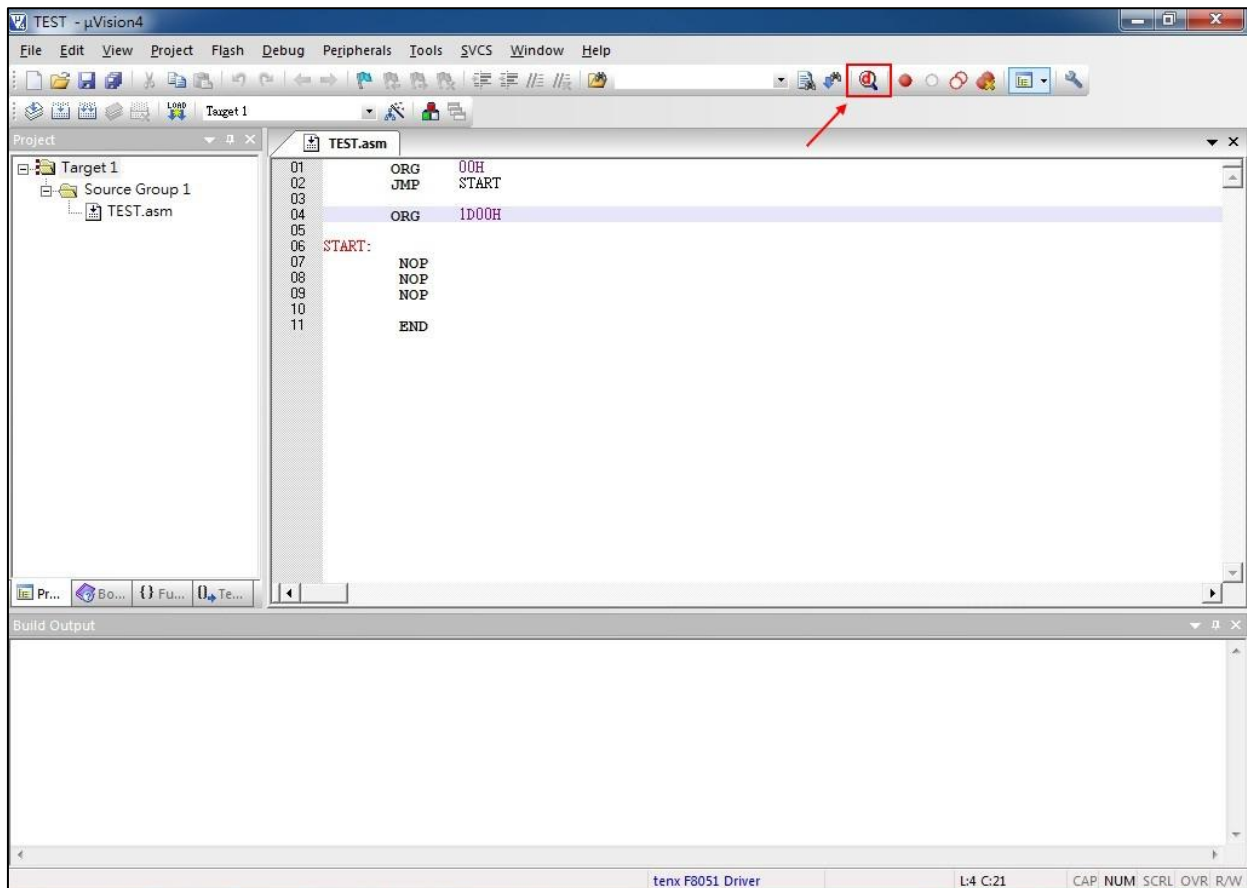

7.2 Click the Debug menu and select “Display Touch Key AP and Run”.

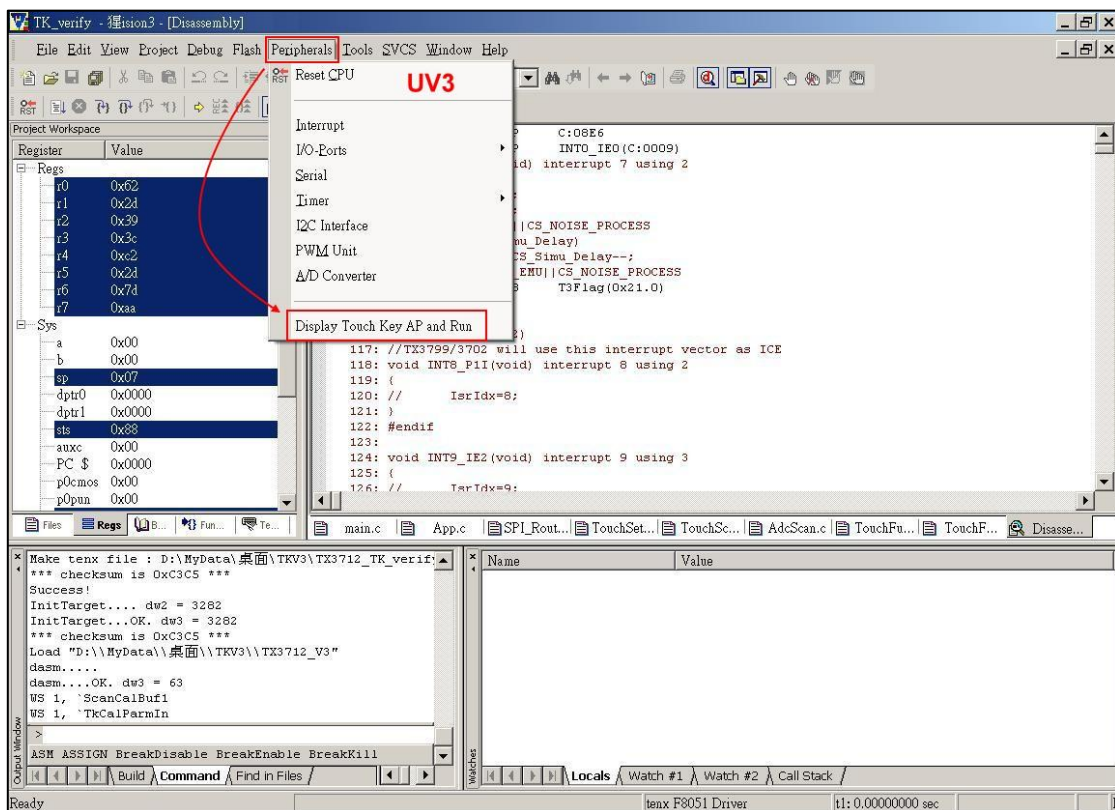
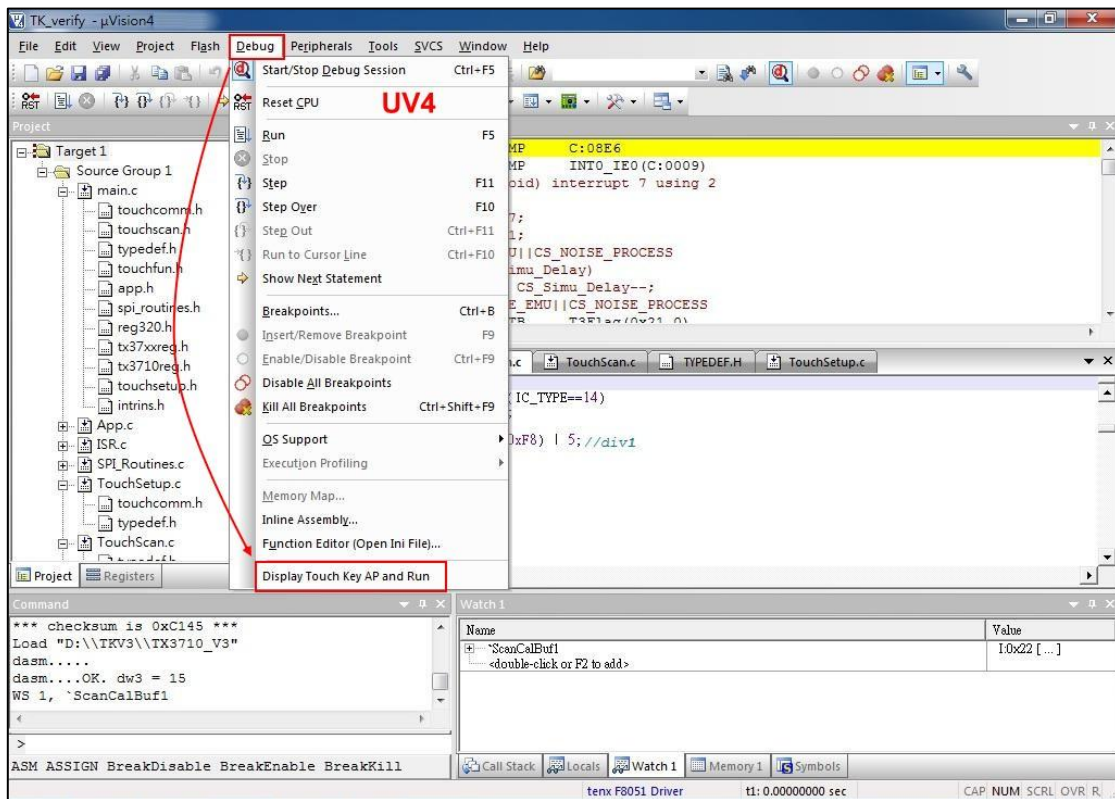

7.3 Fill in TK Data, ex: TK name (address) and TK Bits and Total TK Channels.

Key-in symbol name for watch

TK Name or Address (Ex: "i:0x20"; "x:0xFF00") :

TK data bits(8 or 11) : Total TK channels : 0x

Example1:
 TK data address = i:0x22
 TK data bits = 8
 Total TK channels = 0x3

User must:
 Copy {TKDL[7:0]} of 1st TK into i:0x22
 Copy {TKDL[7:0]} of 2nd TK into i:0x23
 Copy {TKDL[7:0]} of 3rd TK into i:0x24

Example2:
 TK data address = i:0x22
 TK data bits = 11
 Total TK channels : 0x2

User must:
 Copy {5'b00000, TKOVF, TKDH} of 1st TK into i:0x22
 Copy {TKDL[7:0]} of 1st TK into i:0x23
 Copy {5'b00000, TKOVF, TKDH} of 2nd TK into i:0x24
 Copy {TKDL[7:0]} of 2nd TK into i:0x25

Note:
 1. Any touch key channel on ICE pins(maybe P1.2/P1.3) cannot be enabled.
 2. Press OK, user code will auto freerun and ignore any break point.

Cancel
OK

7.4 Click on "OK" button, and the "TK AP" will be show up.

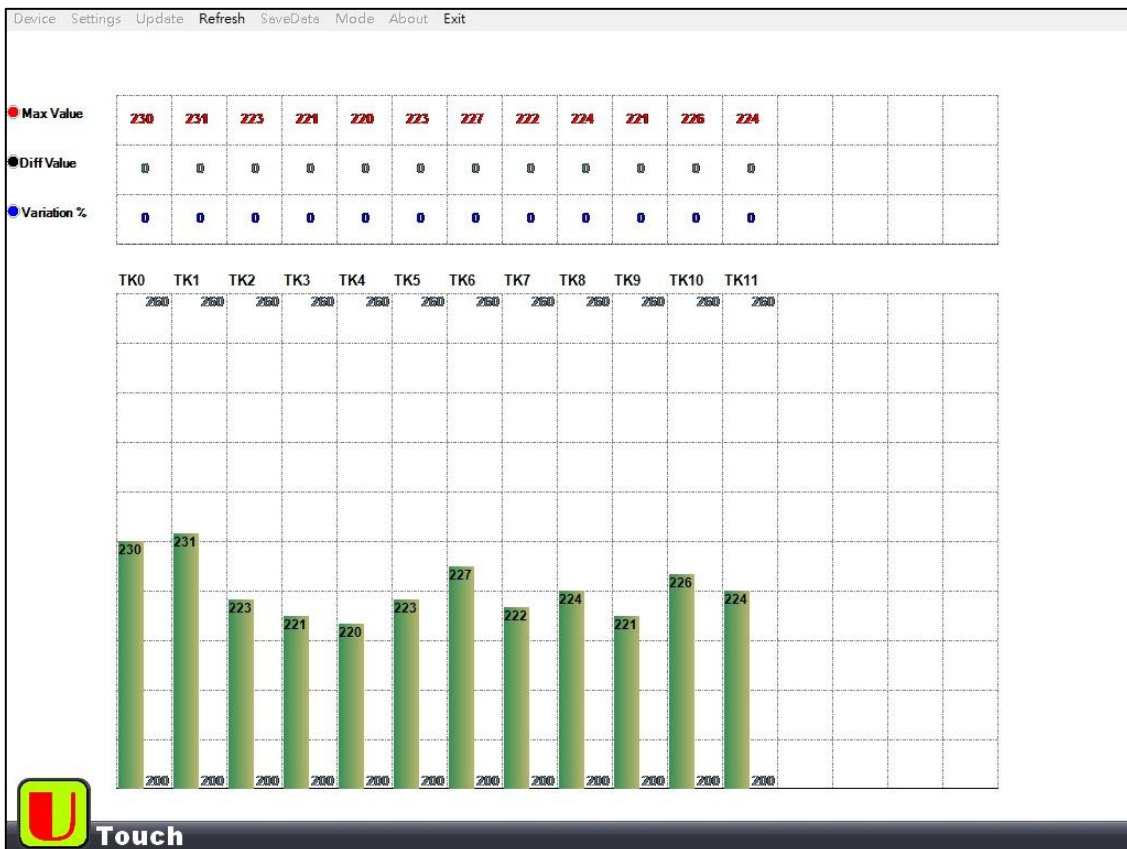

7.5 TK AP Function, as shown below.

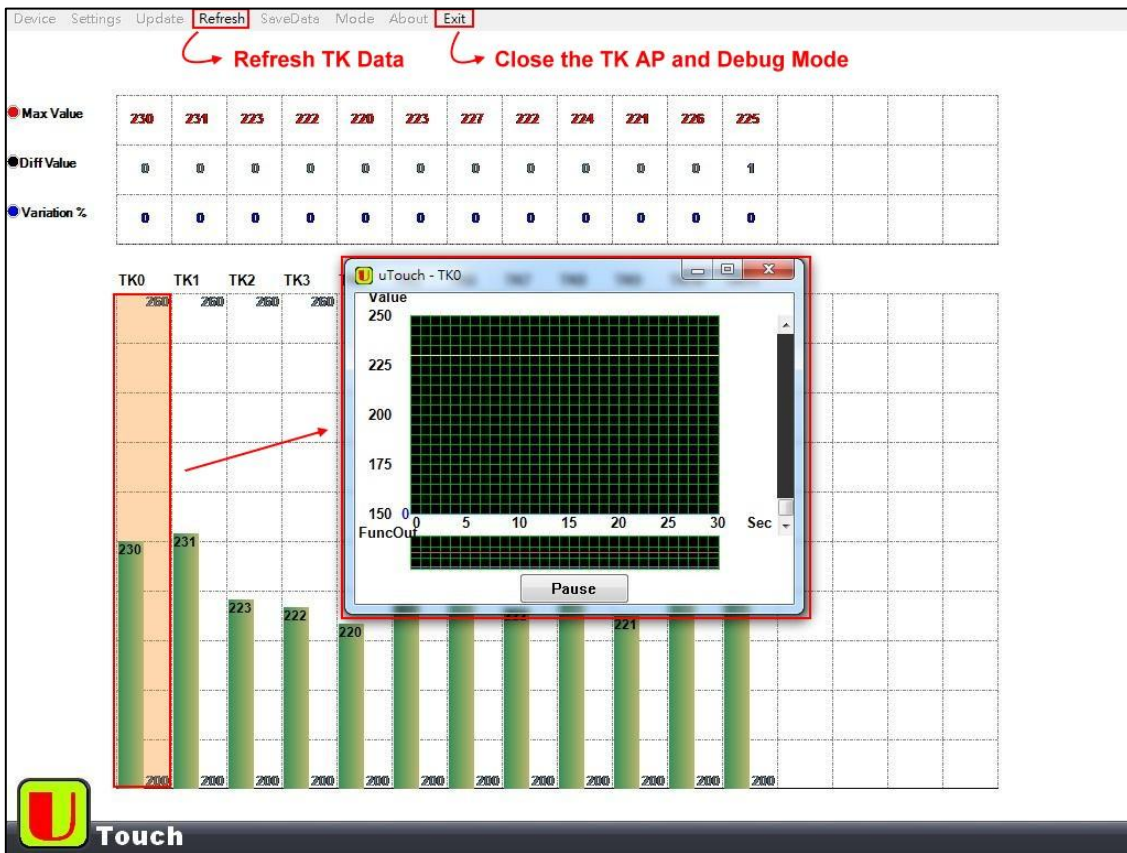

8. How to use LCD Application

The LCD Application can edit and work in Debug Mode, user can use application to simulator LCD Module, please refer to UM-EV22_52XX_LCDAP_SV090 User Manual for more information.

8.1 Click on “Option for Target” button in the main menu, as shown below.

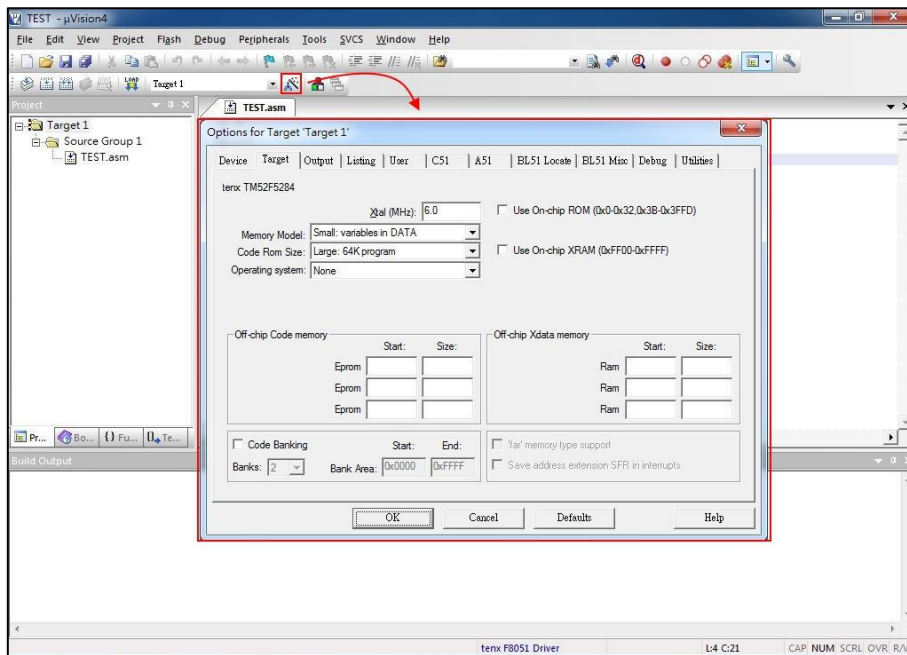

8.2 Click on “setting” Button in “Utilities” Digital box, as shown below.

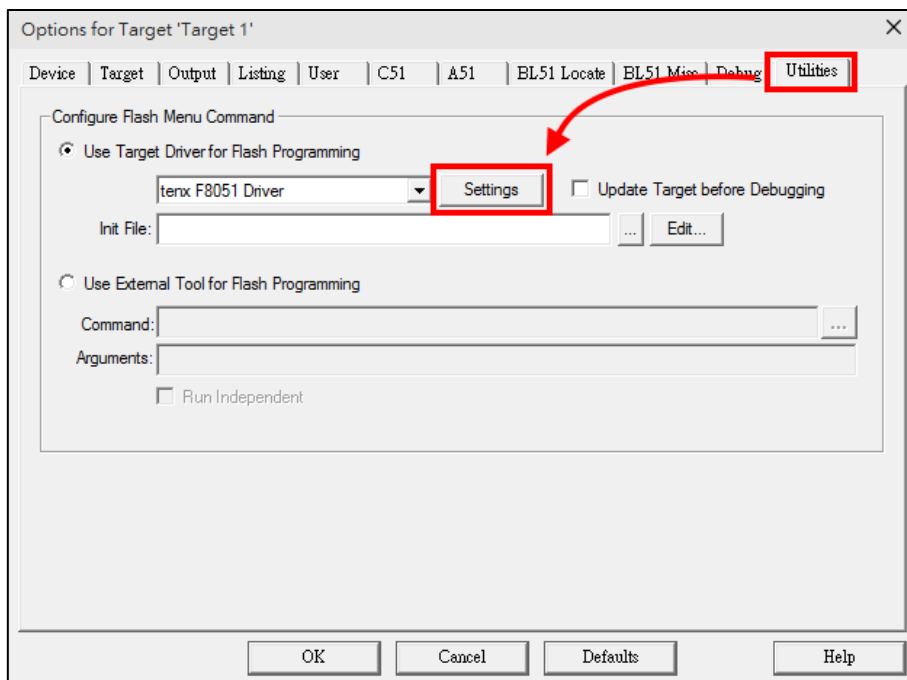

8.3 Click on “Edit LCD” Button and check “show LCD in debug” option, as shown below.

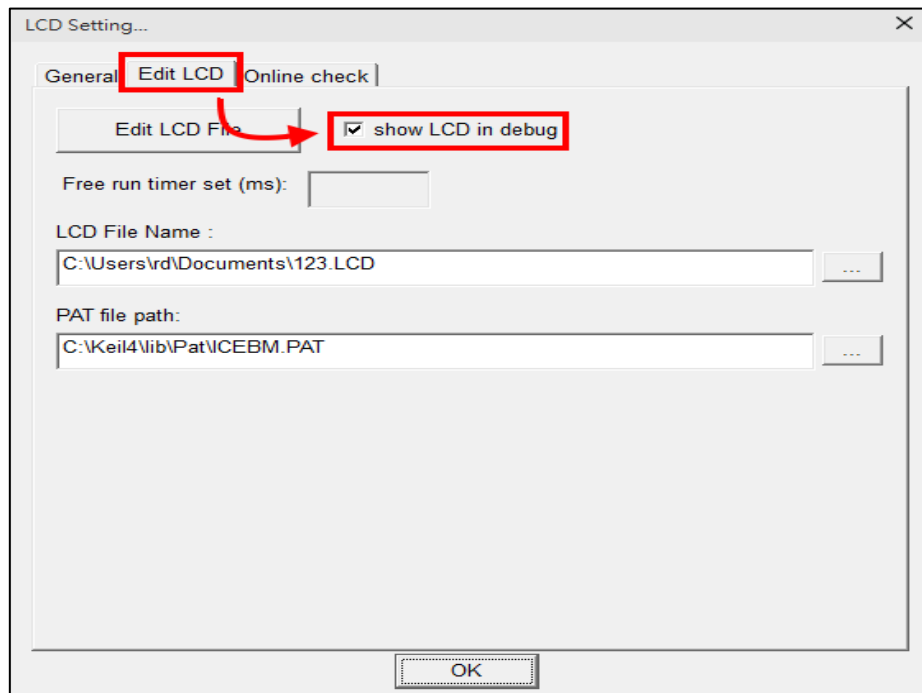

8.4 Click on “Debug” into Debug mode and the LCD Application will be show up, as shown below.

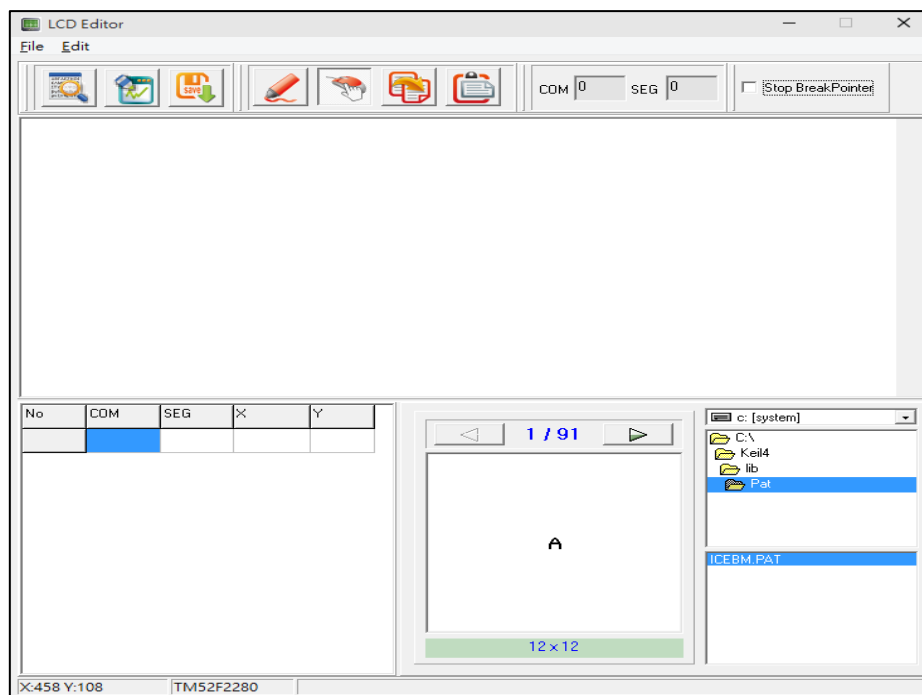

9. LVR Setting Notes

System clock		LVR Options (Minimum)					
Source	Frequency	M5254 M5258 F5284 F5288	F5284B F5288B	F5264 F5268 F5274 F5278	F5264B F5268B F5274B F5278B	F2280 F2284 F2230 F2234	F2280B F2284B F2230B F2234B
FXT/2	8 MHz	/	2.9V	2.9V	2.9V	/	2.9V
FRC/1	7.3 MHz						2.8V
FXT/2	6 MHz	2.9V	2.9V	2.9V	2.9V	2.6V	2.6V
FXT/2	4 MHz	2.3V	2.3V	2.3V	2.3V	2.4V	2.4V
FRC/2	3.7 MHz						2.4V
FXT/2, /4	2 MHz	1.9V	1.9V	1.8V	1.8V	2.4V	2.4V
FRC/4	1.8 MHz						2.4V
FXT/2, /4	1 MHz	1.9V	1.9V	1.8V	1.8V	1.5V	1.5V
FRC/8	0.9 MHz	/	/	/	/		

Note: Please refer to TM52XXXX_02SV11 AP Note for more information.

10. Q & A

Q1: How to program a user file on TWR98 Writer ?

A1: The User must make “ *.tenx ” file to program in “Utilities dialog box settings”, or enter “ Download Mode” and “Debug Mode”, as shown below.

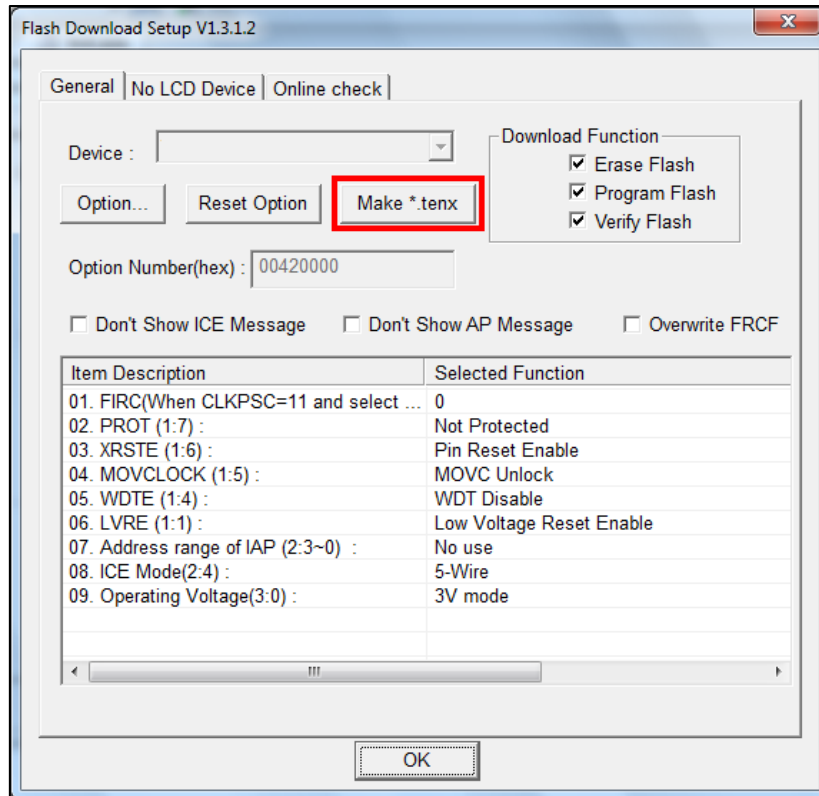

Q2: How to use UV3 and UV4 version in the same time ?

A2: If user wants to install UV3 and UV4 version in the default path (UV3 & UV4 version in C:\ Keil) in the same time, the user musts to change C51 folder name (because there will be two C51 folders), and then install tenx F51 & L51 IDE file, if user needs to use UV3 version, the UV4 version must to change C51 folder name. However, the user wants to install UV3 and UV4 version in the different path (UV3 version in C:\ Keil, UV4 version in D:\ Keil), the tenx F51 & L51 IDE & Keil C version (UV3 or UV4) must be installed in the same path.

Q3: Why the user clicks on “Debug” button as shown below window ?

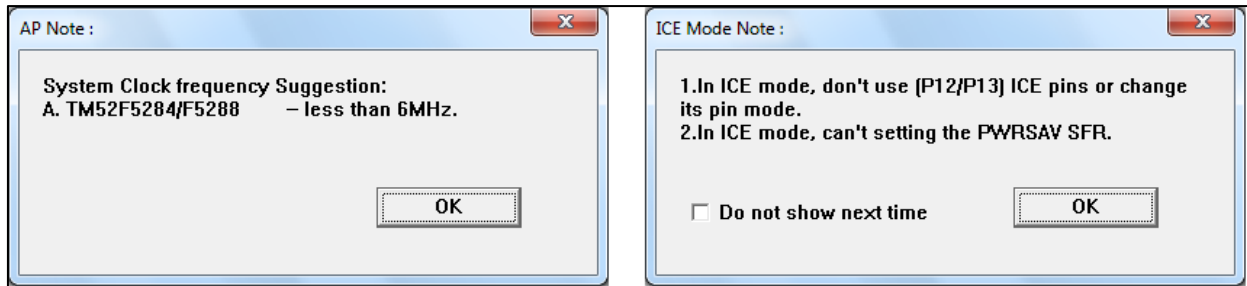

A3: When the user writes program file must be avoid to control P1.2 、 P1.3 pin (For example: P1 Mode configuration change) , if do not show this window in the next time , please check “Do not show next time” option, or to confirm “Don’t Show ICE Message” is checked in the “Flash Download Setup” window.

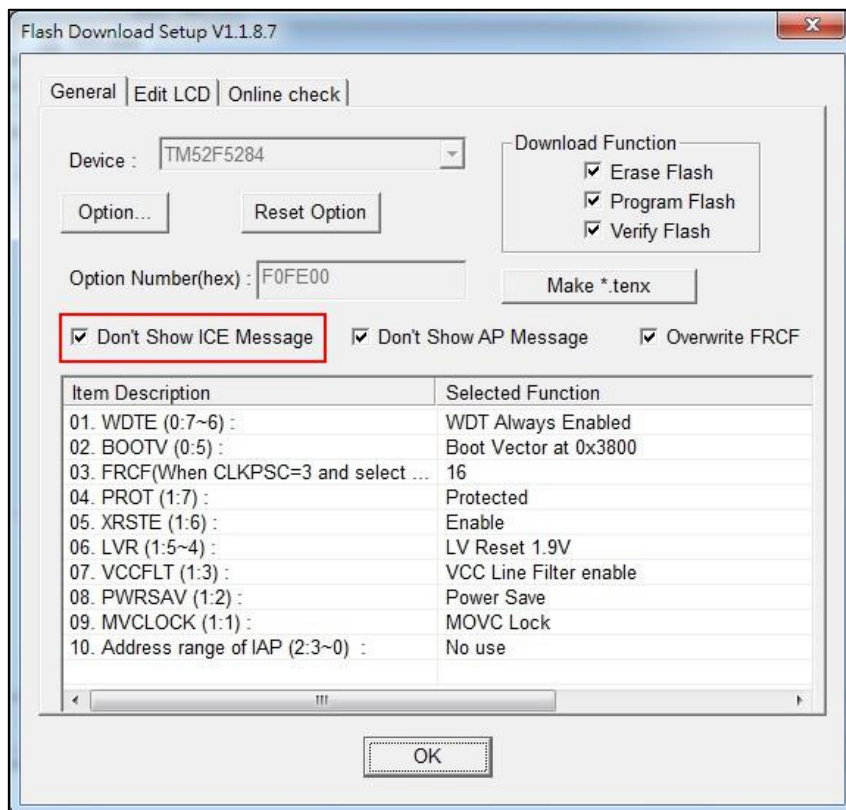

Q4: Why the user clicks on “Debug” button as shown below window, and then exit the “Debug Mode” ?

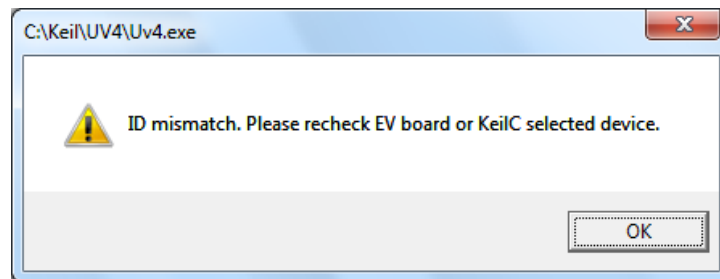

A4: Because the user selects chip model and EV Board model does not match, please recheck chip model and EV Board model.

Q5: Why the user clicks on “Debug” button or “Download” button as shown below window, and then exit the “Debug Mode” or “Download Mode” ?

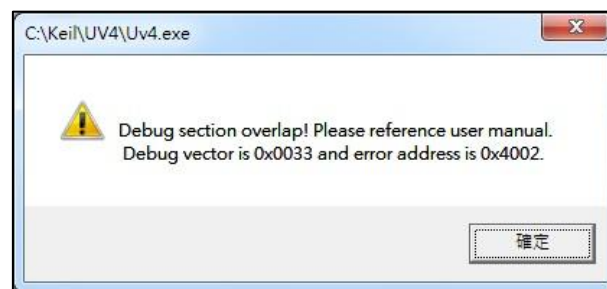

A5: Because the user writes program file is out of “ROM code” range, please refer Note (2) in Page 14.

Q6: Why the user clicks on “Debug” button as shown below window, and then exit the “Debug Mode” ?

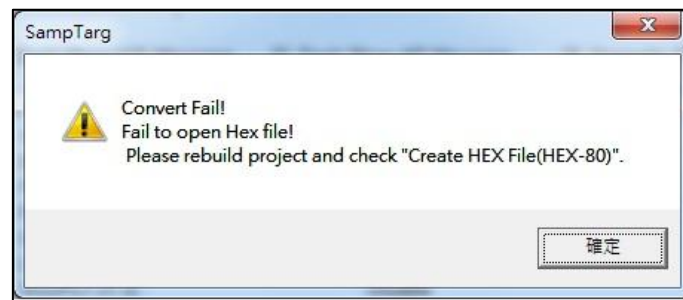

A6: Because the “Create HEX File” is not checked in “Output” option, please refer below figure.

